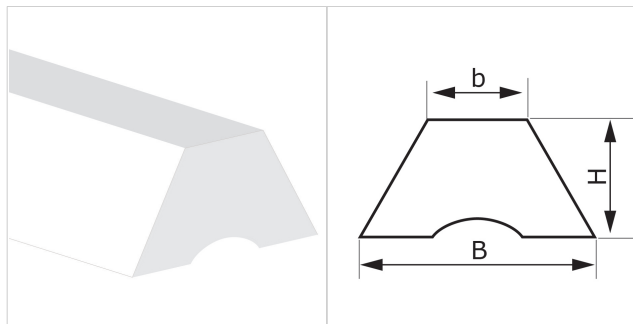

CODE ES53
TYPE
K8 TR
DESCRIPTION

Profiles mainly fitted on conveyor belts as guides.

TECHNICAL SPECIFICATIONS

Material Polyvinyl chloride (PVC)

Hardness 60 ±5 Sh.A

Colour Transparent

Base Grooved

B Upper base 8 mm 0.31 in.

b Bottom base 5 mm 0.20 in.

H Height 5 mm 0.20 in.

Weight 38 gr/m 0.034 oz/in.

Minimum pitch

■ longitudinal	40 mm	1.6 in.
■ transversal	40 mm	1.6 in.

 Minimum pulley diameters⁽¹⁾

■ longitudinal-driving side	30 mm	1.2 in.
■ longitudinal-conveying side	50 mm	2.0 in.
■ transversal-conveying side	--- mm	--- in.

⁽¹⁾ Minimum pulley diameters referred to environment conditions of 20°C

Temperature resistance ⁽²⁾	min.	-10 °C	14 °F
	max	60 °C	140 °F

⁽²⁾ Use with limit values may reduce its life

Roll/bar sizes 300.0 m 984.0 ft

COMPLIANCES

 REACH EC 1907/2006 Regulation and Amendments
 FDA (Food and Drug Administration)

METHOD OF APPLICATION

- Hot air welding
- High frequency welding

NOTES

Issue 22-01-2020

Last Update: 22-01-2020

DISCLAIMER

The information contained in this document describes the features of the CHIORINO product as tested in a laboratory environment at a temperature of +23 degrees °C at 50% relative humidity. It does not necessarily reflect the conditions of industrial use and it does not guarantee the product to be suitable for certain applications. The client remains liable for the proper selection and correct use of the CHIORINO product. CHIORINO cannot be held responsible should damages arise from the use of its products. Necessary alterations to this data can be made without prior notice.