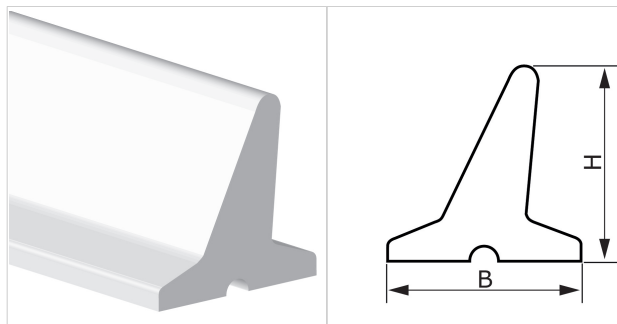

CODE ES397

TYPE
L40 W
DESCRIPTION

PVC inclined lateral profile.

TECHNICAL SPECIFICATIONS

Material Polyvinyl chloride (PVC)

Hardness 60 ±5 Sh.A

Colour White

Base Grooved

B Upper base 23 mm 0.91 in.

b Bottom base --- mm --- in.

H Height 40 mm 1.57 in.

Weight 405 gr/m 0.360 oz/in.

Minimum pitch

■ longitudinal	---	mm	---	in.
■ transversal	55	mm	2.2	in.

 Minimum pulley diameters⁽¹⁾

■ longitudinal-driving side	---	mm	---	in.
■ longitudinal-conveying side	---	mm	---	in.
■ transversal-conveying side	80	mm	3.2	in.

⁽¹⁾ Minimum pulley diameters referred to environment conditions of 20°C

Temperature resistance ⁽²⁾	min.	-10 °C	14	°F
	max	60 °C	140	°F

⁽²⁾ Use with limit values may reduce its life

Roll/bar sizes 2.4 m 7.9 ft

COMPLIANCES

 REACH EC 1907/2006 Regulation and Amendments
 FDA (Food and Drug Administration)

METHOD OF APPLICATION
NOTES

Issue 22-01-2020

Last Update: 22-01-2020

DISCLAIMER

The information contained in this document describes the features of the CHIORINO product as tested in a laboratory environment at a temperature of +23 degrees °C at 50% relative humidity. It does not necessarily reflect the conditions of industrial use and it does not guarantee the product to be suitable for certain applications. The client remains liable for the proper selection and correct use of the CHIORINO product. CHIORINO cannot be held responsible should damages arise from the use of its products. Necessary alterations to this data can be made without prior notice.