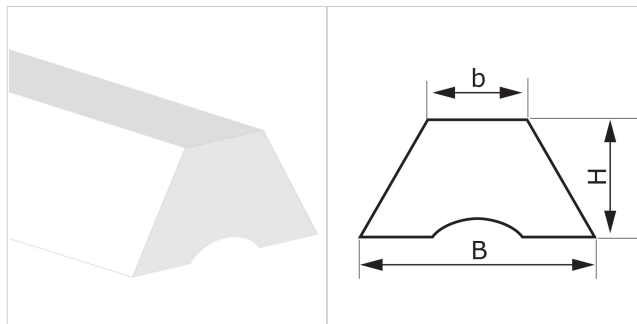

**CODE ES24**
**TYPE**
**K10 TR**
**DESCRIPTION**

Profiles mainly fitted on conveyor belts as guides.

**TECHNICAL SPECIFICATIONS**

Material	Polyvinyl chloride (PVC)		
Hardness	60 ±5 Sh.A		
Colour	Transparent		
Base	Grooved		
B Upper base	10 mm	0.39	in.
b Bottom base	6 mm	0.24	in.
H Height	6 mm	0.24	in.
Weight	57 gr/m	0.051	oz/in.
Minimum pitch			
■ longitudinal	40 mm	1.6	in.
■ transversal	40 mm	1.6	in.
Minimum pulley diameters <sup>(1)</sup>			
■ longitudinal-driving side	50 mm	2.0	in.
■ longitudinal-conveying side	80 mm	3.2	in.
■ transversal-conveying side	--- mm	---	in.
<sup>(1)</sup> Minimum pulley diameters referred to environment conditions of 20°C			
Temperature resistance <sup>(2)</sup>	min.	-10 °C	14 °F
	max	60 °C	140 °F
<sup>(2)</sup> Use with limit values may reduce its life			
Roll/bar sizes	300.0 m	984.0	ft

**COMPLIANCES**

 REACH EC 1907/2006 Regulation and Amendments  
 FDA (Food and Drug Administration)

**METHOD OF APPLICATION**

- Hot air welding
- High frequency welding

**NOTES**

Issue 22-01-2020

Last Update: 22-01-2020

**DISCLAIMER**

The information contained in this document describes the features of the CHIORINO product as tested in a laboratory environment at a temperature of +23 degrees °C at 50% relative humidity. It does not necessarily reflect the conditions of industrial use and it does not guarantee the product to be suitable for certain applications. The client remains liable for the proper selection and correct use of the CHIORINO product. CHIORINO cannot be held responsible should damages arise from the use of its products. Necessary alterations to this data can be made without prior notice.